

AS SHOWN @ DOORS

OPP. HAND @ DOORS

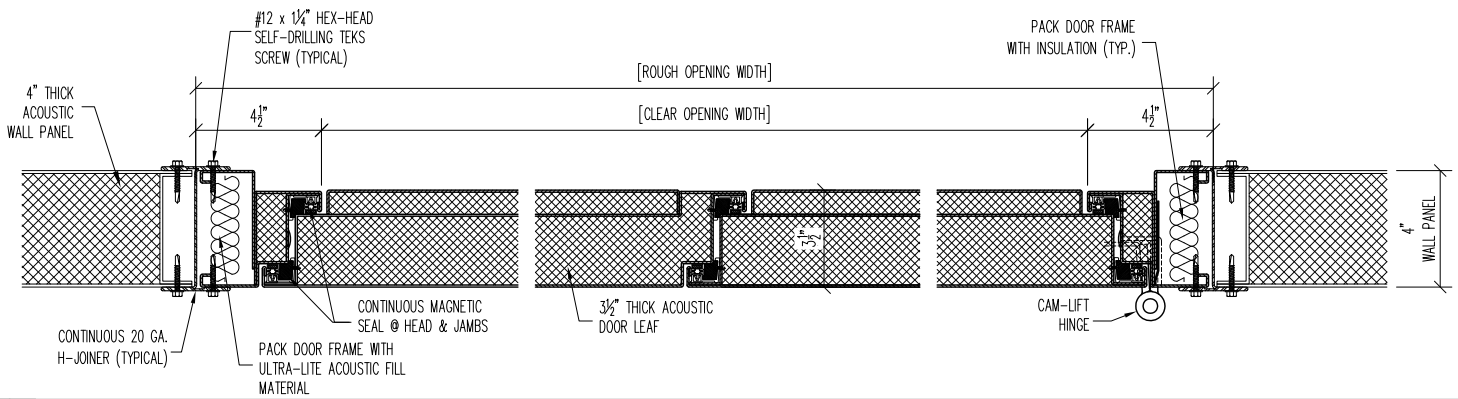

1 JAMB DETAIL

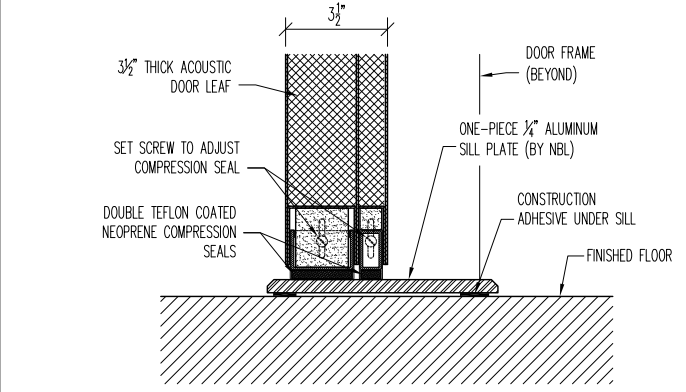
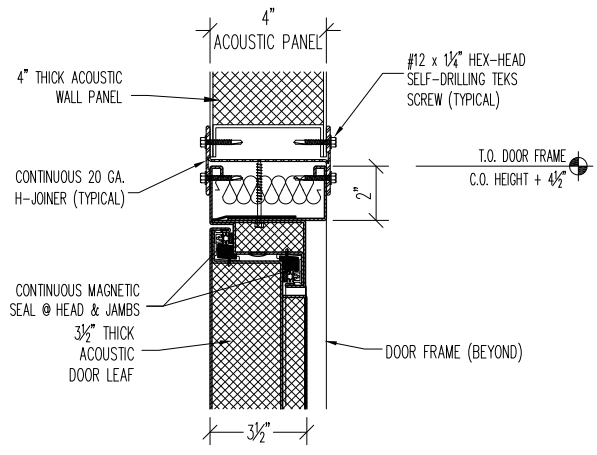

2 HEAD DETAIL

3 SILL DETAIL

**STC-54 DL-DOOR
TYPICAL
INSTALL DETAILS**

PROJECT:		TYPE:	
SUBMITTED BY:	DATE:	ISSUE:	
APPROVED BY:	DATE:	PROJECT No.:	
PROJ. MGR.	SHEET:		

Noise Barriers, LLC
 2001 Kelley Court
 Libertyville, IL 60048
 Phone: (847) 843-0500
 Fax: (847) 843-0501
 www.noisebarriers.com