

AS SHOWN @ DOORS

OPP. HAND @ DOORS

1 JAMB DETAIL

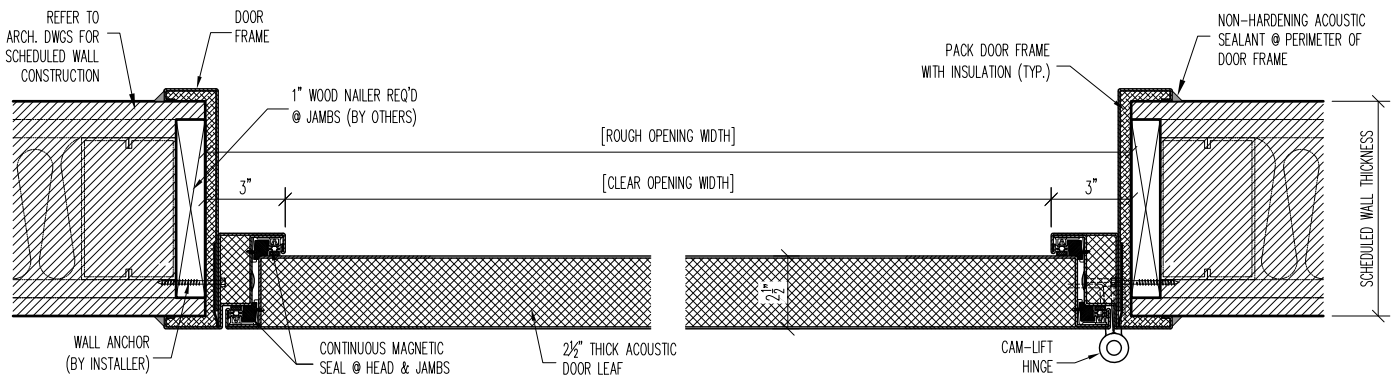
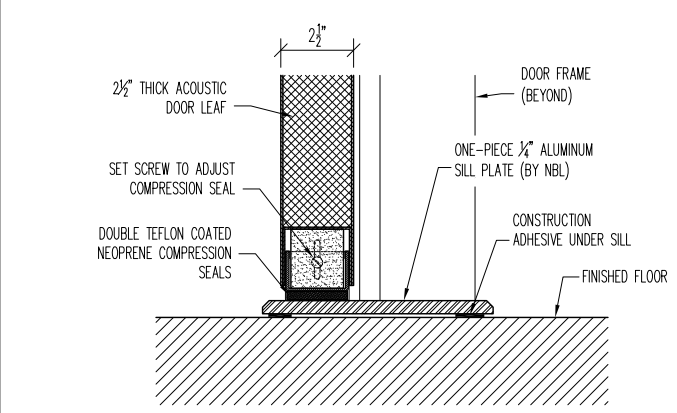
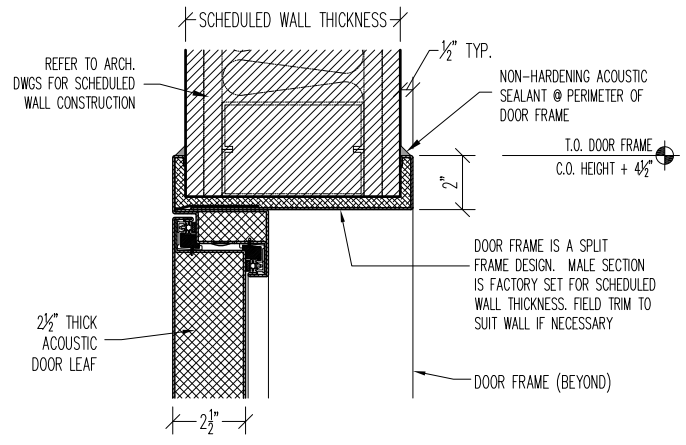

2 HEAD DETAIL

3 SILL DETAIL

STC-52 SL-DOOR  
TYPICAL  
INSTALL DETAILS

PROJECT:		TYPE:
SUBMITTED BY:	DATE:	ISSUE:
APPROVED BY:	DATE:	PROJECT No.:
PROJ. MGR.	SHEET:	

**Noise Barriers, LLC**  
201 Kelley Court  
Libertyville, IL 60048  
Phone: (847) 843-0500  
Fax: (847) 843-0501  
www.noisebarriers.com