

AS SHOWN @ DOORS		
OPP. HAND @ DOORS		

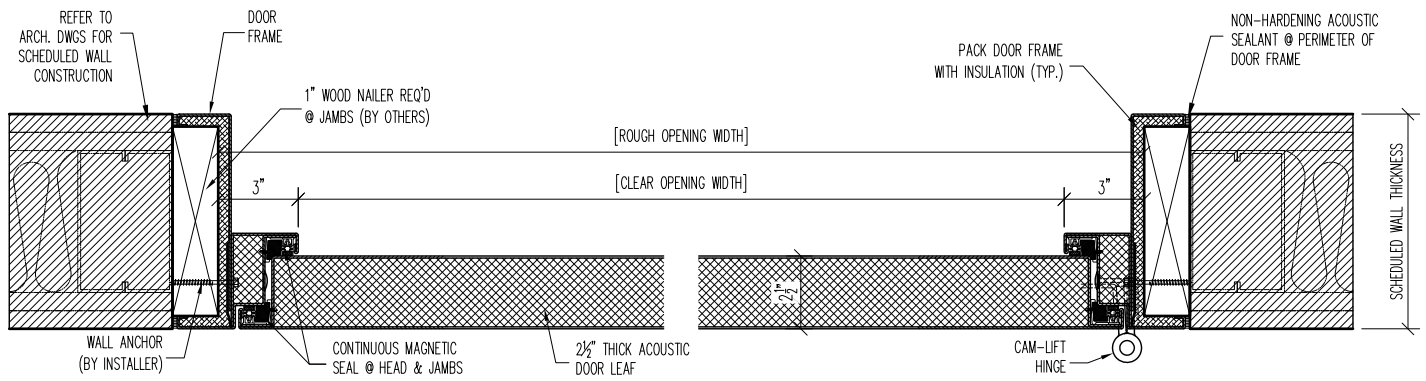

### 1 JAMB DETAIL

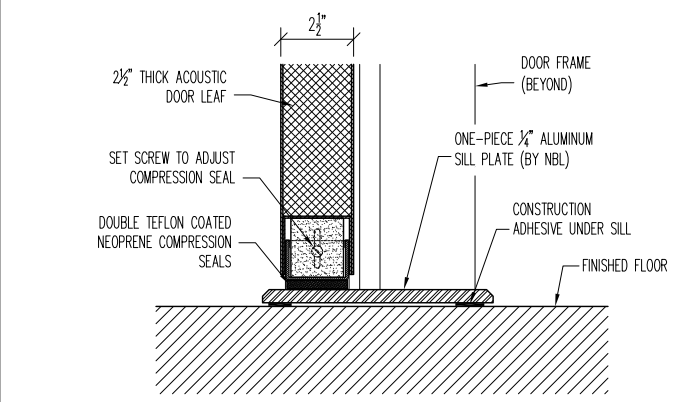
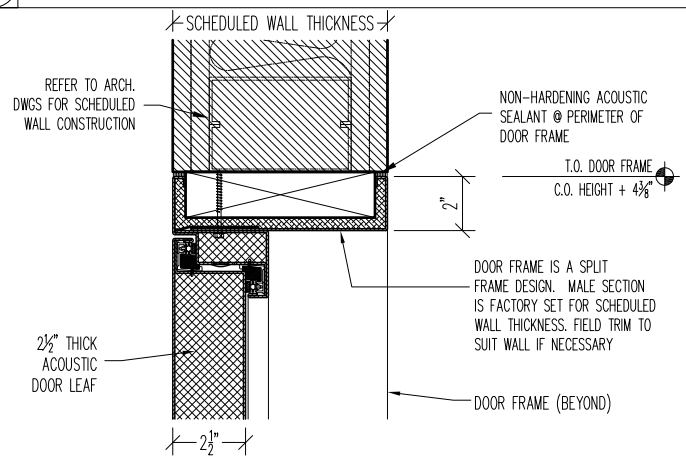

### 2 HEAD DETAIL

### 3 SILL DETAIL

**STC-50 SL-DOOR**  
**TYPICAL**  
**INSTALL DETAILS**

PROJECT:		TYPE:
SUBMITTED BY:	DATE:	ISSUE:
APPROVED BY:	DATE:	PROJECT No.:
PROJ. MGR.	SHEET:	

**Noise Barriers, LLC**  
 201 Kelley Court  
 Libertyville, IL 60048  
 Phone: (847) 843-0500  
 Fax: (847) 843-0501  
 www.noisebarriers.com