

AS SHOWN @ DOORS

OPP. HAND @ DOORS

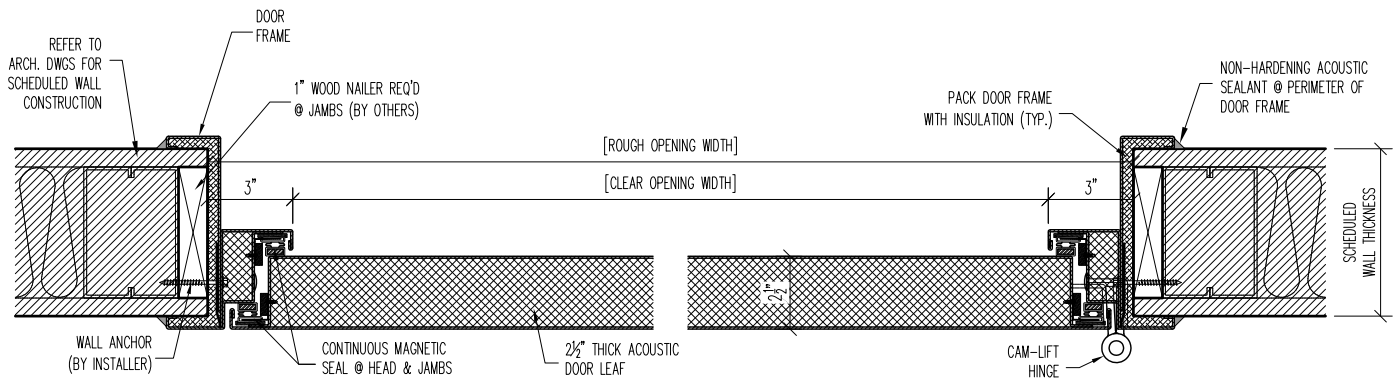

1 JAMB DETAIL

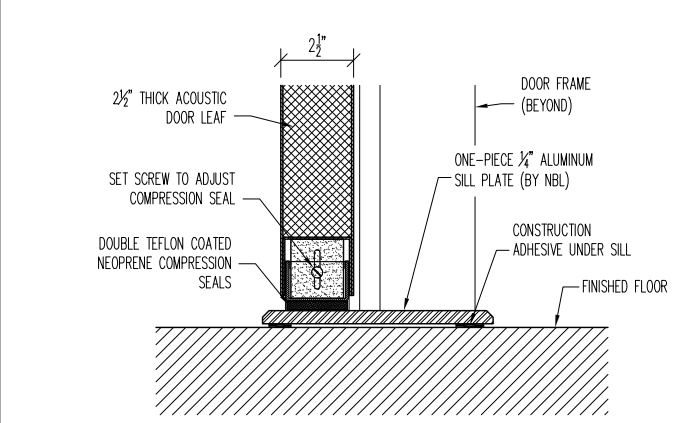
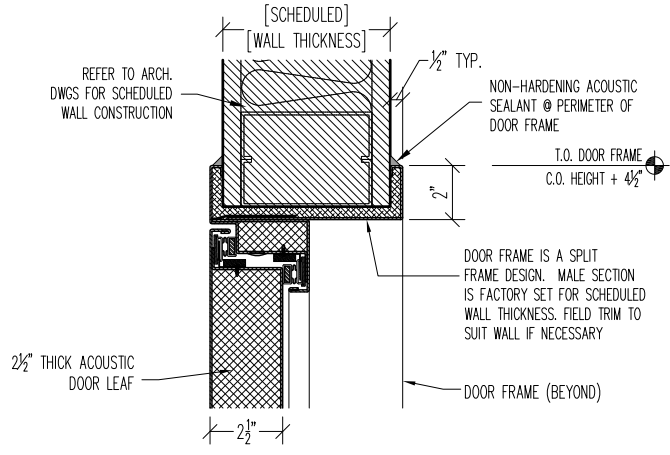

2 HEAD DETAIL

3 SILL DETAIL

STC-52 SL-DOOR
TYPICAL
INSTALL DETAILS

PROJECT:		TYPE:
SUBMITTED BY:	DATE:	ISSUE:
APPROVED BY:	DATE:	PROJECT No.:
PROJ. MGR.	SHEET:	

Noise Barriers, LLC
2001 Kelley Court
Libertyville, IL 60048
Phone: (847) 843-0500
Fax: (847) 843-0501
www.noisebarriers.com