

AS SHOWN @ DOORS		
OPP. HAND @ DOORS		

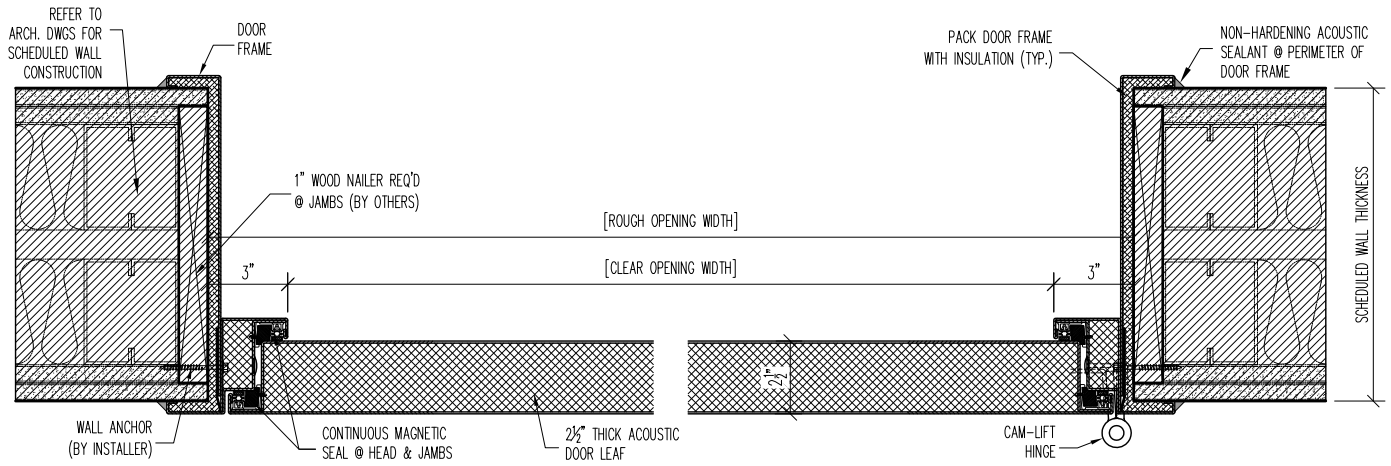

**1 JAMB DETAIL**

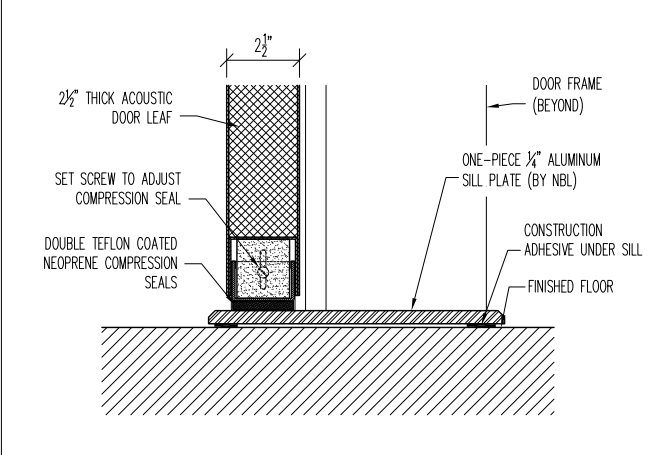
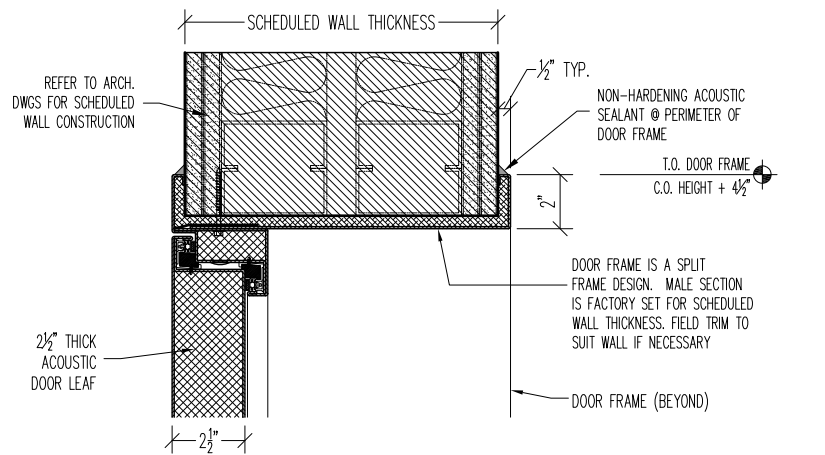

**2 HEAD DETAIL**

**3 SILL DETAIL**

**STC-50 SL-DOOR  
TYPICAL  
INSTALL DETAILS**

PROJECT:		TYPE:
SUBMITTED BY:	DATE:	ISSUE:
APPROVED BY:	DATE:	PROJECT No.:
PROJ. MGR.	SHEET:	

**Noise Barriers, LLC**  
 2001 Kelley Court  
 Libertyville, IL 60048  
 Phone: (847) 843-0500  
 Fax: (847) 843-0501  
 www.noisebarriers.com