

AS SHOWN @ DOORS

OPP. HAND @ DOORS

**1 JAMB DETAIL**

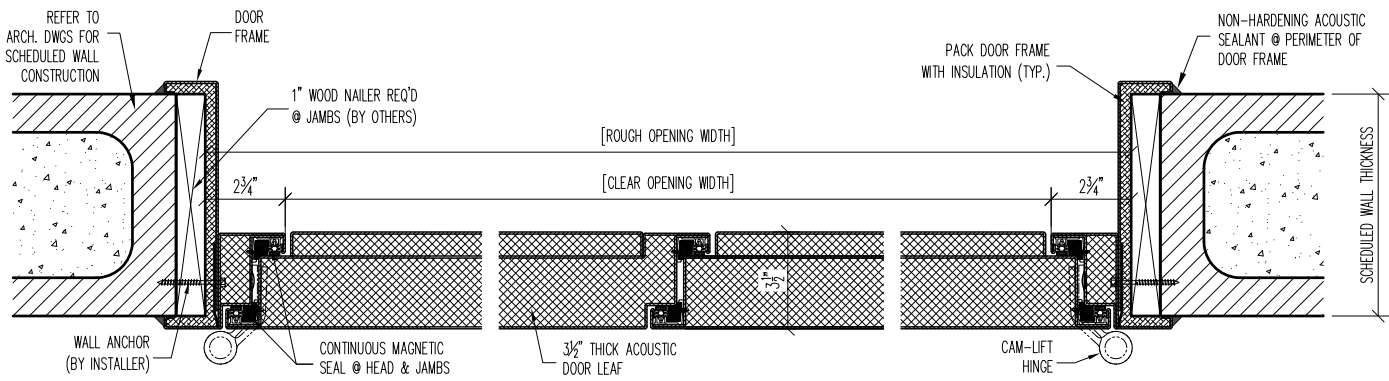
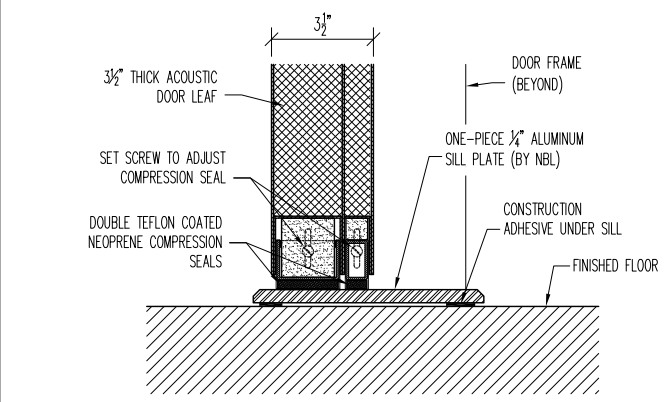
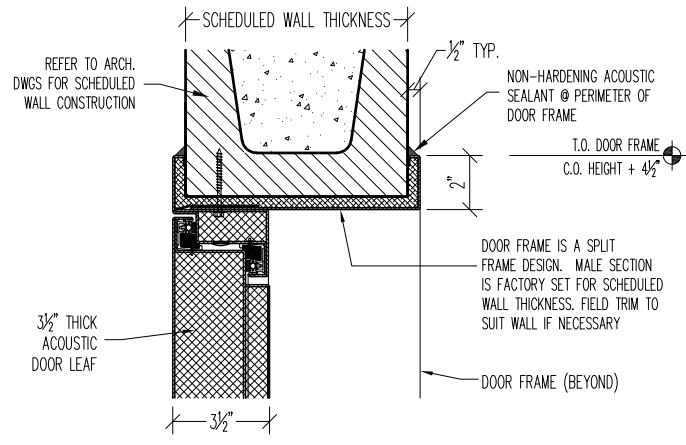

**2 HEAD DETAIL**

**3 SILL DETAIL**

**STC-56 DL-DOOR  
TYPICAL - TYPE 'A'  
INSTALL DETAILS**

PROJECT:		TYPE:
SUBMITTED BY:	DATE:	ISSUE:
APPROVED BY:	DATE:	PROJECT No.:
PROJ. MGR.	SHEET:	

**NOISE BARRIERS**  
401 AIRPORT DRIVE  
NORTH AURORA, IL 60532  
Phone: (847) 843-0500  
Fax: (847) 843-0501  
www.noisebarriers.com